

## QTi DALI 1X36 DIM

QUICKTRONIC INTELLIGENT DALI DIM T8 | ECG dimbar DALI for FL 26 mm



### Bruksområder

- Passer for bruk i nødlyssystemer i henhold til EN 50172/DIN VDE 0108-100
- Installering i nødlyssystemer iht. IEC 61347-2-13, tillegg J
- Industri
- Åpne kontorlandskap, korridorer og lagerrom
- Offentlige bygninger
- Idrettshaller og fabrikker
- Lysstriper
- Egnet for armaturer med beskyttelsesklasse I

### Produktfordeler

- System+ garanti tilgjengelig
- Enkel integrasjon i armaturer takket være samme dimensjoner som DALI GI ECG
- Touch DIM-funksjon for enkel og billig dimming av flere ECG-er
- Samme lysfluks med veksel- og likestrøm
- Dimming av amalgamlamper uten flimring eller nedsatt levetid
- Automatisk omstart etter lampebytte

### Touch DIM og Touch DIM-sensorfunksjon

- Manuell dimming uten kontroller og med standardbrytere
- Inkludert minnefunksjon (dobbelklikk) og myk start

## Produkt datablad

---

### Produktegenskaper

- Korridorfunksjon for direkte tilkobling av ECG til vanlig bevegelsesdetektor
- Korridorfunksjon med forhåndsprogrammert lysprogram
- TouchDIM-funksjon for fri parametrisering av lysverdi og tid for tenning
- Egnet for SMART GRID for rapportering av hovedstrømforbruk og lampens driftstimer
- Veldig lav effekt ved standby: < 0,2 W (A1 BAT)
- Levetid: > 100,000 t (for T = 65 °C ved T<sub>c</sub>)
- Svært mange tenninger: Inntil 300 000
- Dimmeområde: 1...100 % (3...100 % med kompaktlysrør)
- POWER2LAMP-funksjon for optimal tilpassing av ECG-effekt til lampe gjennom lampens levetid
- Nettfrekvens: 0 Hz, 50...60 Hz, likerettet vekselspanning

## Teknisk data

### Elektriske data

Inngangsspenning	198...264 V
Nominell spenning	220...240 V
Nettfrekvensen	50...60 Hz
Likespenning	154...276 V
Driftfrekvens	48...120 kHz
Maksimalt antall ECG på sikring 10 A	17 <sup>1)</sup>
Maksimalt antall ECG på sikring 16 A	28 <sup>1)</sup>
Startstrøm	28 A

<sup>1)</sup> Type B

### Lystekniske data

Starttid	0,6 s <sup>1)</sup>
----------	---------------------

<sup>1)</sup> Optimert tenning med forvarming

### Mål og vekt

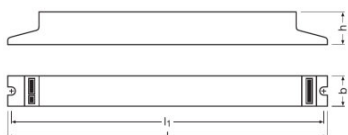

Lengde	360,0 mm
Bredde	30,0 mm
Høyde	21,0 mm
Avstand monteringshull, lengderetning	350,0 mm
Produktvekt	270,00 g
Kabeltverrsnitt, sekundærsiden	0,5...1,5 / 0,5...1,0 mm <sup>2</sup> <sup>1)</sup>
Kabeltverrsnitt, primærside	0,5...1,5 / 0,5...1,0 mm <sup>2</sup> <sup>1)</sup>

<sup>1)</sup> Massiv leder / Fleksibel

### Temperatures & operating conditions

Omgivelsestemperatur-område	-20...+50 °C
-----------------------------	--------------

## Produkt datablad

<b>Relativ fuktighet</b>	5...85 % <sup>1)</sup>
--------------------------	------------------------

<sup>1)</sup> Maksimalt 56 dager/år ved 85 %

### Levetid

<b>ECG levetid</b>	100000 h <sup>1)</sup>
--------------------	------------------------

<sup>1)</sup> Ved T<sub>case</sub> = 65°C ved tc punkt / 10% utfallsprosent

### Forventet levetid

Produktnavn	Lampeggruppe				
QTi DALI 1X36 DIM	DULUX L 36 W	ECG omgivelsestemperatur [ta]	40	50	60
		temperatur på tc-punkt [° C]	50	60	70
		levetid [t]	100000	100000	100000
	L 36 W	ECG omgivelsestemperatur [ta]	40	50	60
		temperatur på tc-punkt [° C]	50	60	70
		levetid [t]	100000	100000	100000

### Ytterligere produktdata

<b>Suitable for lamp power (1 lamp)</b>	36 W
---	------

### Egenskaper

<b>Dimmingsgrensesnitt</b>	DALI / Touch DIM / Touch DIM Sensor
<b>Dimmingsområde</b>	1...100 % <sup>1)</sup>
<b>Dimbar</b>	Yes
<b>Overopphetningsbeskyttelse</b>	Effektreduksjonen og slukking ved T > 75 ° C på tc punktet
<b>Egnet for armaturer med beskyttelsesklas</b>	I
<b>Sikker driftsstop ved endt levetid</b>	EOL T.2
<b>Maksimum ledningslengde, ECG/lampe</b>	1.0 m / 1.5 m

<sup>1)</sup> Luminous flux

### Sertifikater og standarder

<b>Godkjenningsmerke - godkjenning</b>	VDE / VDE-EMC / EL / EAC / RCM / CCC
<b>Standarder</b>	Acc. to EN 61347-2-3/Acc. to EN 60929/Acc. to EN 55015:2006 + A1:2007/Acc. to EN 61000-3-2/Acc. to EN 61547/Acc. to IEC 62386-101:Ed1/Acc. to IEC 62386-102:Ed1
<b>EEI – Energimerke</b>	A1 BAT
<b>Beskyttelsesklasse</b>	I
<b>Beskyttelses type</b>	IP20

Logistiske data

Commodity code	850410809000
----------------	--------------

Koblingsskjema

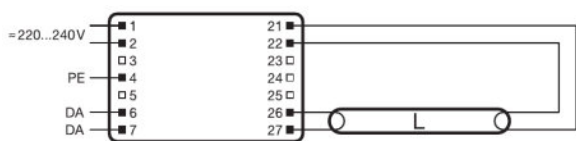

Wiring diagram

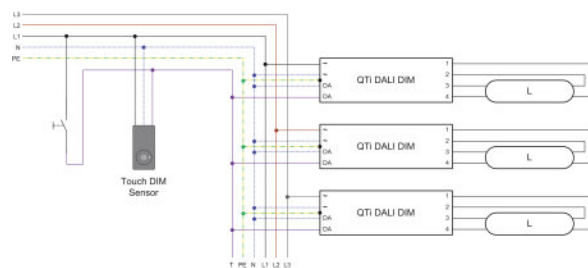

Wiring diagram

## Produkt datablad

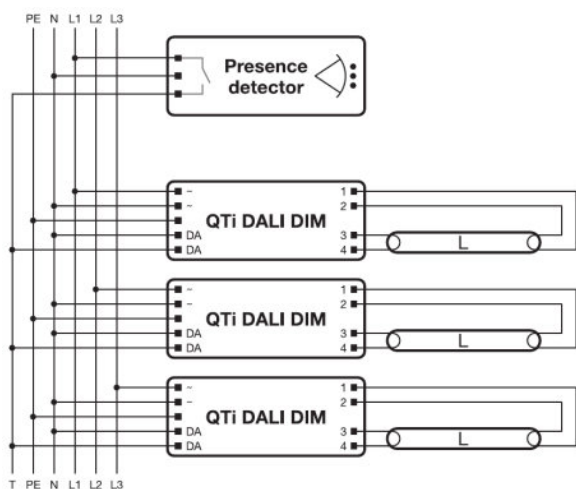



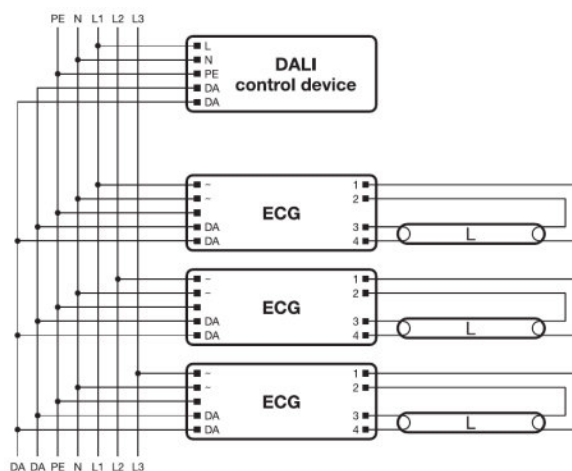







Wiring diagram











Wiring diagram

### Last ned data

Fil	
	Addon Technical Information 502689_Frequent switching Quicktronic
	Addon Technical Information 502785_ECG lifetime - QUICKTRONIC (DALI) DIM
	Product Datasheet 321484_ATI QTİ DALI 1x36 DIM (G+GB)
	Brochures 333874_Bochure &#150; DALI partner
	Certificates 335097_INOTEC
	Certificates 335125_ENECVDE-Marks approval
	Certificates 335135_Manufacturer's declaration &#150; Burning-in of fluorescent lamps
	Certificates 335153_Manufacturer's declaration &#150; Low stand-by
	Certificates 335154_Manufacturer's declaration &#150; EN 55015:2006+A1:2007 (300 MHz)
	Certificates 335169_Manufacturer's declaration &#150; LampECG combinations: Frequent switching
	Certificates 335190_Manufacturer's declaration &#150; Additional hints

## Produkt datablad

	Certificates 592319_EAC certificate for Quicktronics QT
	Certificates 504208_VDE-EMC-CERTIFICATE QTi DALI DIM
	Declarations of conformity 334957_Declaration of conformity
	Installation/Operation notice 493509_Technical application guide QUICKTRONIC Intelligent DALI DIM (GB)
	Operating instructions 592413_EAC QTi T8 DALI DIM
	CAD data 3-dim 313432_360x30x21 1881281
	CAD data 3-dim 313433_360x30x21 1881281
	CAD data 3-dim 313453_360x30x21 1881281
	CAD data PDF 313406_360x30x21 1881281

## Logistikk data

Product kode	Produkt beskrivelse	Forpakkings enhet (stk/enhet)	Dimensjoner (lengde x bredde x høyde)	Volum	Brutto vekt
4050300870427	QTi DALI 1X36 DIM	NO: VS 20	392 mm x 98 mm x 165 mm	6.34 dm <sup>3</sup>	5639.99 g

The mentioned product code describes the smallest quantity unit which can be ordered. One shipping unit can contain one or more single products. When placing an order, for the quantity please enter single or multiples of a shipping unit.

## Referanser / Lenker

For mer informasjon om systemgarantien samt vilkårene og betingelsene i garantien besøk

▶ [www.osram.com/system-guarantee](http://www.osram.com/system-guarantee)

## Ansvarsfraskrivelse

Endres uten varsel. Sørg alltid for å bruke den nyeste versjonen.

## QTi DALI 1X36 DIM

QUICKTRONIC INTELLIGENT DALI DIM T8 | ECG dimbar DALI for FL 26 mm

Produktnavn	Lampegruppe	Nominal wattage + Power loss	Nominell strøm	Lysstrøm ved 35 ° C	Antall belynings utganger
QTi DALI 1X36 DIM	DULUX F 36 W	36.00 W	0.16 A	2900 lm	1
	DULUX L 36 W	36.00 W	0.16 A	2900 lm	1
	L 30 W	36.00 W	0.16 A	2250 lm	1
	L 32 W C	36.00 W	0.16 A	2300 lm	1
	L 36 W -1	36.00 W	0.16 A	3350 lm	1
	L 36 W	36.00 W	0.16 A	3350 lm	1
	L 36 W XT	36.00 W	0.16 A	3350 lm	1
	L 36 W XXT	36.00 W	0.16 A	3350 lm	1
	L 38 W	36.00 W	0.16 A	3300 lm	1