

## QTi DALI 1X58 DIM

QUICKTRONIC INTELLIGENT DALI DIM T8 | ECG dimbar DALI for FL 26 mm



### Bruksområder

- Passer for bruk i nødlyssystemer i henhold til EN 50172/DIN VDE 0108-100
- Installering i nødlyssystemer iht. IEC 61347-2-13, tillegg J
- Industri
- Åpne kontorlandskap, korridorer og lagerrom
- Offentlige bygninger
- Idrettshaller og fabrikker
- Lysstriper
- Egnet for armaturer med beskyttelsesklasse I

### Produktfordeler

- System+ garanti tilgjengelig
- Enkel integrasjon i armaturer takket være samme dimensjoner som DALI GI ECG
- Touch DIM-funksjon for enkel og billig dimming av flere ECG-er
- Samme lysfluks med veksel- og likestrøm
- Dimming av amalgamlamper uten flimring eller nedsatt levetid
- Automatisk omstart etter lampebytte

### Touch DIM og Touch DIM-sensorfunksjon

- Manuell dimming uten kontroller og med standardbrytere
- Inkludert minnefunksjon (dobbelklikk) og myk start

## Produkt datablad

---

### Produktegenskaper

- Korridorfunksjon for direkte tilkobling av ECG til vanlig bevegelsesdetektor
- Korridorfunksjon med forhåndsprogrammert lysprogram
- TouchDIM-funksjon for fri parametrisering av lysverdi og tid for tenning
- Egnet for SMART GRID for rapportering av hovedstrømforbruk og lampens driftstimer
- Veldig lav effekt ved standby: < 0,2 W (A1 BAT)
- Levetid: > 100,000 t (for T = 65 °C ved T<sub>c</sub>)
- Svært mange tenninger: Inntil 300 000
- Dimmeområde: 1...100 % (3...100 % med kompaktlysrør)
- POWER2LAMP-funksjon for optimal tilpassing av ECG-effekt til lampe gjennom lampens levetid
- Nettfrekvens: 0 Hz, 50...60 Hz, likerettet vekselspanning

## Teknisk data

### Elektriske data

Inngangsspenning	198...264 V
Nominell spenning	220...240 V
Nettfrekvensen	50...60 Hz
Likespenning	154...276 V
Driftfrekvens	46...120 kHz
Maksimalt antall ECG på sikring 10 A	17 <sup>1)</sup>
Maksimalt antall ECG på sikring 16 A	28 <sup>1)</sup>
Startstrøm	28 A

<sup>1)</sup> Type B

### Lystekniske data

Starttid	0,6 s <sup>1)</sup>
----------	---------------------

<sup>1)</sup> Optimert tenning med forvarming

### Mål og vekt



Lengde	360,0 mm
Bredde	30,0 mm
Høyde	21,0 mm
Avstand monteringshull, lengderetning	350,0 mm
Produktvekt	270,00 g
Kabeltverrsnitt, sekundærsiden	0,5...1,5 / 0,5...1,0 mm <sup>2</sup> <sup>1)</sup>
Kabeltverrsnitt, primærside	0,5...1,5 / 0,5...1,0 mm <sup>2</sup> <sup>1)</sup>

<sup>1)</sup> Massiv leder / Fleksibel

### Temperatures & operating conditions

Omgivelsestemperatur-område	-20...+50 °C
-----------------------------	--------------

## Produkt datablad

Relativ fuktighet	5...85 % <sup>1)</sup>
-------------------	------------------------

<sup>1)</sup> Maksimalt 56 dager/år ved 85 %

### Levetid

ECG levetid	100000 h <sup>1)</sup>
-------------	------------------------

<sup>1)</sup> Ved T<sub>case</sub> = 65°C ved tc punkt / 10% utfallsprosent

### Forventet levetid

Produktnavn	Lampeggruppe				
QTi DALI 1X58 DIM	L 58 W	ECG omgivelsestemperatur [ta]	40	50	60
		temperatur på tc-punkt [° C]	50	60	70
		levetid [t]	100000	100000	100000

### Ytterligere produktdata

Suitable for lamp power (1 lamp)	58 W
----------------------------------	------

### Egenskaper

Dimmingsgrensesnitt	DALI / Touch DIM / Touch DIM Sensor
Dimmingsområde	1...100 % <sup>1)</sup>
Dimbar	Yes
Overopphetningsbeskyttelse	Effektreduksjonen og slukking ved T > 75 ° C på tc punktet
Egnet for armaturer med beskyttelsesklas	I
Sikker driftsstopp ved endt levetid	EOL T.2
Maksimum ledningslengde, ECG/lampe	1.0 m / 1.5 m

<sup>1)</sup> Luminous flux

### Sertifikater og standarder

Godkjenningssmerke - godkjenning	VDE / VDE-EMC / EL / EAC / RCM / CCC
Standarder	Acc. to EN 61347-2-3/Acc. to EN 60929/Acc. to EN 55015:2006 + A1:2007/Acc. to EN 61000-3-2/Acc. to EN 61547/Acc. to IEC 62386-101:Ed1/Acc. to IEC 62386-102:Ed1
EEL – Energimerke	A1 BAT
Beskyttelsesklasse	I
Beskyttelses type	IP20

### Logistiske data

Commodity code	850410809000
----------------	--------------

Koblingsskjema

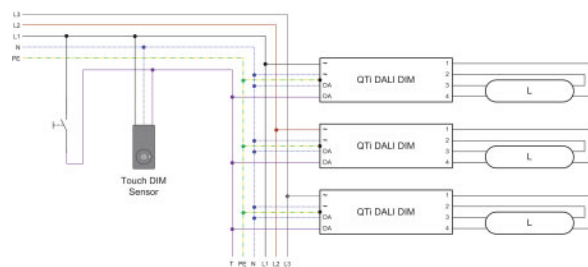
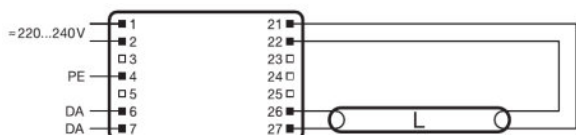

Wiring diagram

Wiring diagram

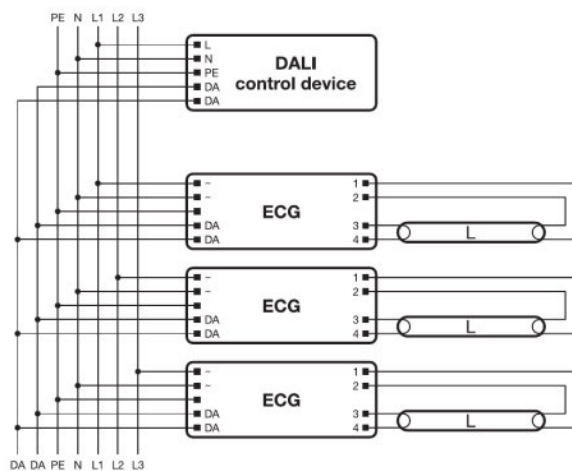
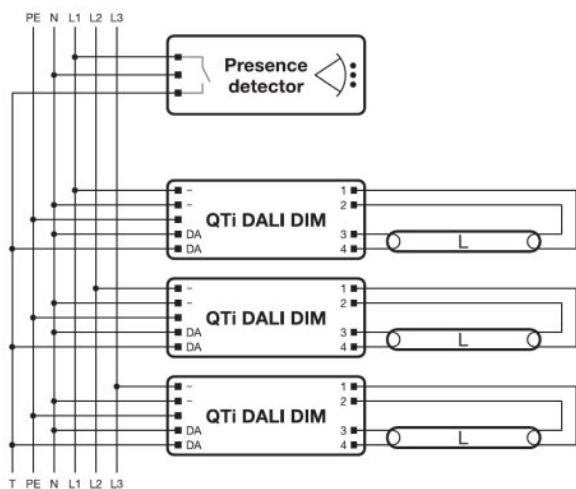



















Wiring diagram

Wiring diagram

Last ned data

## Produkt datablad

Fil	
	Addon Technical Information 502689_Frequent switching Quicktronic
	Addon Technical Information 502785_ECG lifetime - QUICKTRONIC (DALI) DIM
	Brochures 333874_Bochure &#150; DALI partner
	Certificates 335097_INOTEC
	Certificates 335125_ENECVDE-Marks approval
	Certificates 335135_Manufacturer's declaration &#150; Burning-in of fluorescent lamps
	Certificates 335153_Manufacturer's declaration &#150; Low stand-by
	Certificates 335154_Manufacturer's declaration &#150; EN 55015:2006+A1:2007 (300 MHz)
	Certificates 335169_Manufacturer's declaration &#150; LampECG combinations: Frequent switching
	Certificates 335190_Manufacturer's declaration &#150;Additional hints
	Certificates 592319_EAC certificate for Quicktronics QT
	Certificates 504208_VDE-EMC-CERTIFICATE QTl DALI DIM
	Declarations of conformity 334957_Declaration of conformity
	Installation/Operation notice 493509_Technical application guide QUICKTRONIC Intelligent DALI DIM (GB)
	Operating instructions 592413_EAC QTl T8 DALI DIM
	CAD data 3-dim 313432_360x30x21 1881281
	CAD data 3-dim 313433_360x30x21 1881281
	CAD data 3-dim 313453_360x30x21 1881281
	CAD data PDF 313406_360x30x21 1881281

## Logistikk data

## Produkt datablad

Product kode	Produkt beskrivelse	Forpakkings enhet (stk/enhet)	Dimensjoner (lengde x bredde x høyde)	Volum	Brutto vekt
4050300870823	QTi DALI 1X58 DIM	NO: VS 20	392 mm x 98 mm x 165 mm	6.34 dm <sup>3</sup>	5679.99 g

The mentioned product code describes the smallest quantity unit which can be ordered. One shipping unit can contain one or more single products. When placing an order, for the quantity please enter single or multiples of a shipping unit.

---

### Referanser / Lenker

For mer informasjon om systemgarantien samt vilkårene og betingelsene i garantien besøk

▶ [www.osram.com/system-guarantee](http://www.osram.com/system-guarantee)

---

### Ansvarsfraskrivelse

Endres uten varsel. Sørg alltid for å bruke den nyeste versjonen.

## QTi DALI 1X58 DIM

QUICKTRONIC INTELLIGENT DALI DIM T8 | ECG dimbar DALI for FL 26 mm

Produktnavn	Lampeggruppe	Nominal wattage + Power loss	Nominell strøm	Lysstrøm ved 35 ° C	Antall belysnings utganger
QTi DALI 1X58 DIM	L 58 W	56.00 W	0.25 A	5000 lm	1
	L 58 W XT	56.00 W	0.25 A	5000 lm	1
	L 58 W XXT	56.00 W	0.25 A	5000 lm	1