

QTi DALI-T/E 1x18...57 DIM

QUICKTRONIC INTELLIGENT DALI DIM CFL | ECG dimbar DALI for CFL



Bruksområder

- Passer for bruk i nødlyssystemer i henhold til EN 50172/DIN VDE 0108-100
- Installering i nødlyssystemer iht. IEC 61347-2-13, tillegg J
- Åpne kontorlandskap, korridorer og lagerrom
- Offentlige bygninger
- Egnet for armaturer med beskyttelsesklasse I

Produktfordeler

- System+ garanti tilgjengelig
- Enkel integrasjon i armaturer takket være samme dimensjoner som DALI GI ECG

Touch DIM og Touch DIM-sensorfunksjon

- Manuell dimming uten kontroller og med standardbrytere
- Inkludert minnefunksjon (dobbeltklikk) og myk start

Produktegenskaper

- Korridorfunksjon for direkte tilkobling av ECG til vanlig bevegelsesdetektor
- Korridorfunksjon med forhåndsprogrammert lysprogram
- TouchDIM-funksjon for fri parametrisering av lysverdi og tid for tenning
- Egnet for SMART GRID for rapportering av hovedstrømforbruk og lampens driftstimer
- Veldig lav effekt ved standby: < 0,2 W (A1 BAT)
- Levetid: > 100,000 t (for T = 65 °C ved T_c)
- Svært mange tenninger: Inntil 300 000
- Dimmeområde: 1...100 % (3...100 % med kompaktlysrør)
- POWER2LAMP-funksjon for optimal tilpassing av ECG-effekt til lampe gjennom lampens levetid
- Nettfrekvens: 0 Hz, 50...60 Hz, likerettet vekselspanning

Teknisk data

Elektriske data

Nominell spenning	220...240 V
Nettfrekvensen	50...60 Hz
Likespenning	154...276 V
Driftfrekvens	42...130 kHz
Maksimalt antall ECG på sikring 10 A	12 ¹⁾
Maksimalt antall ECG på sikring 16 A	19 ¹⁾
Startstrøm	30 A

¹⁾ Type B

Lystekniske data

Starttid	0,6 s ¹⁾
----------	---------------------

¹⁾ Optimert tenning med forvarming

Mål og vekt

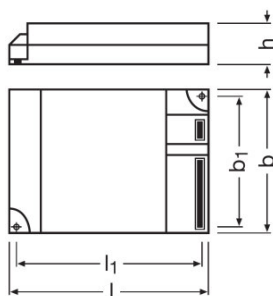

Lengde	123,0 mm
Bredde	79,0 mm
Høyde	33,0 mm
Avstand monteringshull, lengderetning	129,5 mm
Avstand monteringshull, bredde	67,0 mm
Produktvekt	227,00 g
Kabeltverrsnitt, primærside	0,5...1,5 mm ²

Temperatures & operating conditions

Omgivelsestemperatur-område	+10...+50 °C
Relativ fuktighet	5...85 % ¹⁾

¹⁾ Maksimalt 56 dager/år ved 85 %

Produkt datablad

Levetid

ECG levetid	100000 h ¹⁾
--------------------	------------------------

¹⁾ Ved Tcase = 65°C ved tc punkt / 10% utfallsprosent

Produktnavn	Lampeggruppe				
QTi DALI-T/E 1x18...57 DIM	DULUX D/E 26 W	ECG omgivelsestemperatur [ta]	40	50	60
		temperatur på tc-punkt [° C]	55	65	75
		levetid [t]	100000	100000	90000
	DULUX L 24 W	ECG omgivelsestemperatur [ta]	40	50	60
		temperatur på tc-punkt [° C]	55	65	75
		levetid [t]	100000	100000	90000
	DULUX L 40 W	ECG omgivelsestemperatur [ta]	40	50	60
		temperatur på tc-punkt [° C]	55	65	75
		levetid [t]	100000	100000	90000
	DULUX T/E 18 W	ECG omgivelsestemperatur [ta]	40	50	60
		temperatur på tc-punkt [° C]	50	60	70
		levetid [t]	100000	100000	100000
	DULUX T/E 32 W	ECG omgivelsestemperatur [ta]	40	50	60
		temperatur på tc-punkt [° C]	55	65	75
		levetid [t]	100000	100000	90000
	DULUX T/E 32 W CONSTANT	ECG omgivelsestemperatur [ta]	40	50	60
		temperatur på tc-punkt [° C]	55	65	75
		levetid [t]	100000	100000	90000
	DULUX T/E 42 W	ECG omgivelsestemperatur [ta]	40	50	60
		temperatur på tc-punkt [° C]	55	65	75
		levetid [t]	100000	100000	90000
	DULUX T/E 42 W CONSTANT	ECG omgivelsestemperatur [ta]	40	50	60
		temperatur på tc-punkt [° C]	55	65	75
		levetid [t]	100000	100000	90000
FC 22 W	ECG omgivelsestemperatur [ta]	40	50	60	
	temperatur på tc-punkt [° C]	55	65	75	
	levetid [t]	100000	100000	90000	
FC 40 W	ECG omgivelsestemperatur [ta]	40	50	60	
	temperatur på tc-punkt [° C]	55	65	75	
	levetid [t]	100000	100000	90000	

Ytterligere produktdata

Produkt datablad

Fotnote bare for produktet	Ekstra kabelklemme, se kapittel om ECG festeordning - kabelklemm
Suitable for lamp power (1 lamp)	18...57 W

Egenskaper

Dimmingsgrensesnitt	DALI / Touch DIM / Touch DIM Sensor
Dimmingsområde	3...100 % ¹⁾
Dimbar	Yes
Overopphetningsbeskyttelse	Ja
Egnet for armaturer med beskyttelsesklas	I
Sikker driftsstopp ved endt levetid	EOL T.2
Maksimum ledningslengde, ECG/lampe	0,5 m

¹⁾ Luminous flux

Sertifikater og standarder

Godkjenningsmerke - godkjenning	VDE / VDE-EMC / EL / EAC / RCM / CCC
Standarder	Acc. to EN 61347-2-3/Acc. to EN 60929/Acc. to EN 55015:2006 + A1:2007/Acc. to EN 61000-3-2/Acc. to EN 61547/Acc. to IEC 62386-101:Ed1/Acc. to IEC 62386-102:Ed1
EEI – Energimerke	A1 BAT
Beskyttelsesklasse	I
Beskyttelses type	IP20

Logistiske data

Commodity code	850410809000
----------------	--------------

Koblingsskjema

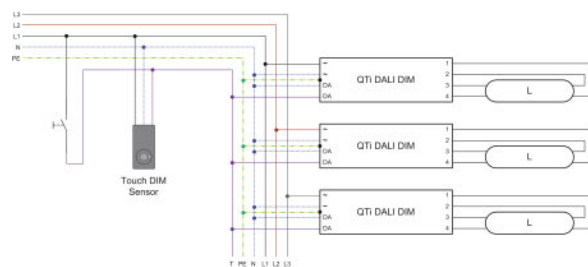
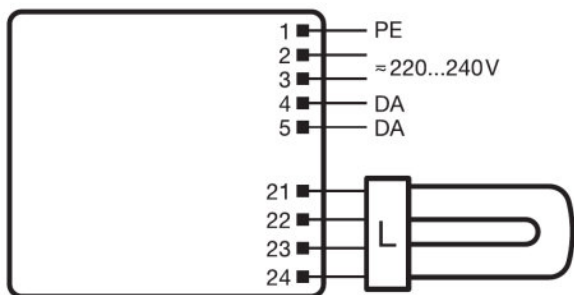

Wiring diagram

Wiring diagram

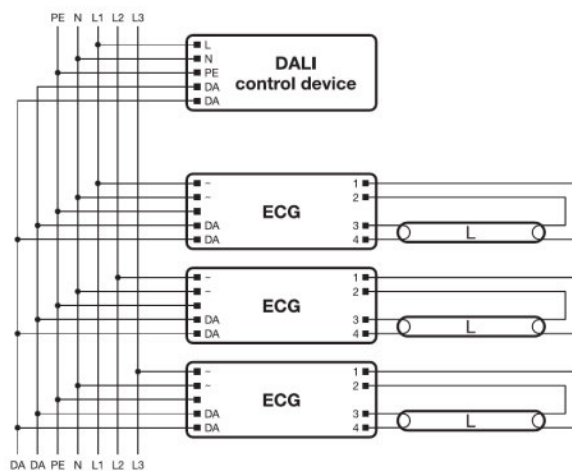
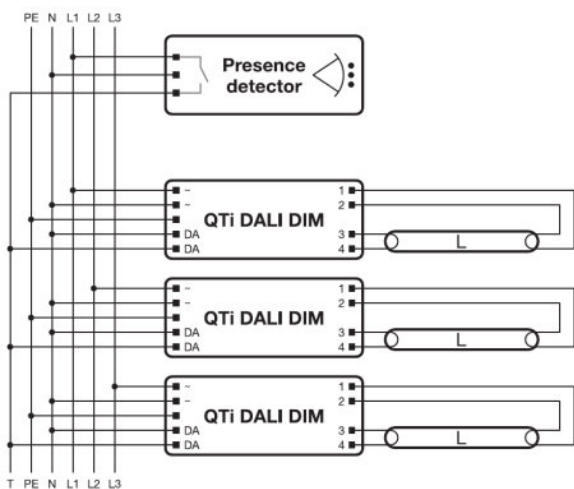





















Wiring diagram

Wiring diagram

Last ned data

Produkt datablad

Fil	
	Addon Technical Information 502689_Frequent switching Quicktronic
	Addon Technical Information 502785_ECG lifetime - QUICKTRONIC (DALI) DIM
	Brochures 333874_Bochure – DALI partner
	Certificates 334953_EMC-Marks approval
	Certificates 335097_INOTEC
	Certificates 335125_ENECVDE-Marks approval
	Certificates 335135_Manufacturer's declaration – Burning-in of fluorescent lamps
	Certificates 335153_Manufacturer's declaration – Low stand-by
	Certificates 335154_Manufacturer's declaration – EN 55015:2006+A1:2007 (300 MHz)
	Certificates 335160_Manufacturer's declaration – Lamp T5 FC QTl-TE DALI...DIM ECG combinations
	Certificates 335169_Manufacturer's declaration – Lamp ECG combinations: Frequent switching
	Certificates 335190_Manufacturer's declaration – Additional hints
	Certificates 504208_VDE-EMC-CERTIFICATE QTl DALI DIM
	Declarations of conformity 334767_Declaration of conformity
	Installation/Operation notice 493509_Technical application guide QUICKTRONIC Intelligent DALI DIM (GB)
	Operating instructions 596666_EAC QTl DALI TE DIM
	CAD data 3-dim 321612_QTi DALI-TE 1x18-57 DIM
	CAD data 3-dim 321615_QTi DALI-TE 1x18-57 DIM
	CAD data 3-dim 321616_QTi DALI-TE 1x18-57 DIM
	CAD data PDF 321619_QTi DALI-TE 1x18-57 DIM

Logistikk data

Produkt datablad

Product kode	Produkt beskrivelse	Forpakkings enhet (stk/enhet)	Dimensjoner (lengde x bredde x høyde)	Volum	Brutto vekt
4008321060808	QTi DALI-T/E 1x18...57 DIM	NO: VS 20	428 mm x 78 mm x 257 mm	8.58 dm ³	4380.00 g

The mentioned product code describes the smallest quantity unit which can be ordered. One shipping unit can contain one or more single products. When placing an order, for the quantity please enter single or multiples of a shipping unit.

Referanser / Lenker

For mer informasjon om systemgarantien samt vilkårene og betingelsene i garantien besøk

▶ www.osram.com/system-guarantee

Ansvarsfraskrivelse

Endres uten varsel. Sørg alltid for å bruke den nyeste versjonen.

QTi DALI-T/E 1x18...57 DIM

QUICKTRONIC INTELLIGENT DALI DIM CFL | ECG dimbar DALI for CFL

Produktnavn	Lampeguppe	Nominal wattage + Power loss	Nominell strøm	Lysstrøm ved 25 ° C	Antall belysningsutganger	Lysstrøm ved 35 ° C
QTi DALI-T/E 1x18...57 DIM	DULUX D/E 18 W	20.00 W	0.09 A	1200 lm	1	
	DULUX D/E 26 W	29.00 W	0.13 A	1800 lm	1	
	DULUX L 24 W	26.00 W	0.12 A		1	1200 lm
	DULUX L 40 W	45.00 W	0.20 A		1	3500 lm
	DULUX T/E 18 W	20.00 W	0.09 A	1200 lm	1	
	DULUX T/E 26 W	29.00 W	0.13 A	1800 lm	1	
	DULUX T/E 26 W CONSTANT	29.00 W	0.13 A	1800 lm	1	
	DULUX T/E 32 W	36.00 W	0.16 A	2400 lm	1	
	DULUX T/E 32 W CONSTANT	36.00 W	0.16 A	2400 lm	1	
	DULUX T/E 42 W	47.00 W	0.21 A	3200 lm	1	
	DULUX T/E 42 W CONSTANT	47.00 W	0.21 A	3200 lm	1	
	FC 22 W	26.00 W	0.12 A		1	1800 lm
	FC 40 W	45.00 W	0.20 A		1	3200 lm