

QTi 4X14/24 DIM

QUICKTRONIC INTELLIGENT DIM T5 | ECG dimbar 1...10 V for FL 16 mm

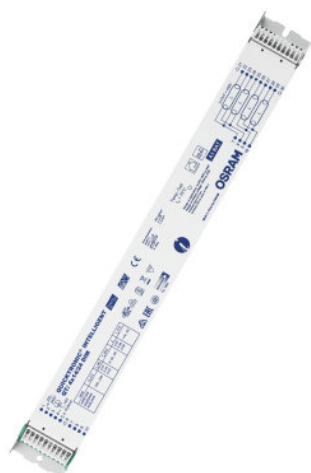

Bruksområder

- Passer for nødinstallasjoner
- Industri
- Åpne kontorlandskap, korridorer og lagerrom
- Offentlige bygninger
- Egnet for armaturer med beskyttelsesklasse I

Produktfordeler

- Samme lysfluks med veksel- og likestrøm
- Perfekt lampestart for bruk med bevegelsessensorer
- Dimming av amalgamlamper uten flimring eller nedsatt levetid
- Veldig høy virkningsgrad takket være utkoblingsteknologi
- Automatisk omstart etter lampebytte
- ECG-er samsvarer med MINERGIE-standarden på grunn av lavt standby-forbruk
- Konfigurerbare nødstrømkaraktistikker

Produkt datablad

Produktegenskaper

- Betjening via 1...10 V-grensesnitt
- Matespenning: 220...240 V
- Nettfrekvens: 0 Hz | 50 Hz | 60 Hz
- Nettspenning: 198...264 V
- Dimmeområde: 1...100 % lysfluks
- lampestart: innen 0,6 s
- Levetid: > 100,000 t (for T = 65 °C ved T_c)
- Automatisk utkobling av defekte lamper og ved levetidsslutt (EoL T.2)
- Energieffektivitetsindeks EEI: A1 BAT
- Overtemperaturvern: Temperaturstyring ved høye t_c temperaturer
- Sikkerhet: to EN 61347-2-3
- Lampedrift: til EN 60929
- RI-demping: til EN 55015:2006+A1:2007+A2:2009/CISPR 15
- Overharmonisk til EN 61000-3-2
- Immunitet iht. EN 61547

Teknisk data

Elektriske data

Inngangsspenning	198...264 V
Nominell spenning	220...240 V
Nettfrekvensen	50...60 Hz
Likespenning	154...276 V
Driftfrekvens	40...100 kHz
Maksimalt antall ECG på sikring 10 A	8 ¹⁾
Maksimalt antall ECG på sikring 16 A	13 ¹⁾
Startstrøm	45 A

¹⁾ Type B

Lystekniske data

Starttid	0,6 s ¹⁾
----------	---------------------

¹⁾ Optisert tenning med forvarming

Mål og vekt



Lengde	360,0 mm
Bredde	40,0 mm
Høyde	21,0 mm
Avstand monteringshull, lengderetning	350,0 mm
Produktvekt	397,00 g
Kabeltverrsnitt, sekundærsiden	0,5...1,5 / 0,5...1,0 mm ² ¹⁾
Kabeltverrsnitt, primærside	0,5...1,5 / 0,5...1,0 mm ² ¹⁾

¹⁾ Massiv leder / Fleksibel

Temperatures & operating conditions

Omgivelsestemperatur-område	+10...+50 °C
-----------------------------	--------------

Produkt datablad

Relativ fuktighet	5...85 % ¹⁾
-------------------	------------------------

¹⁾ Maksimalt 56 dager/år ved 85 %

Levetid

ECG levetid	100000 h ¹⁾
-------------	------------------------

¹⁾ Ved T_{case} = 65°C ved tc punkt / 10% utfallsprosent

Ytterligere produktdata

Suitable for lamp power (4 lamps)	14...24 W
-----------------------------------	-----------

Egenskaper

Dimmingsgrensesnitt	1...10 V
Dimmingsområde	1...100 % ¹⁾
Dimbar	Yes
Overopphetningsbeskyttelse	Effektreduksjonen og slukking ved T > 75 ° C på tc punktet
Egnet for armaturer med beskyttelsesklas	I
Sikker driftsstopp ved endt levetid	EOL T.2
Maksimum ledningslengde, ECG/lampe	1,0 m

¹⁾ Luminous flux

Sertifikater og standarder

Godkjenningsmerke - godkjenning	VDE / VDE-EMC / EL / EAC / RCM / CCC
Standarder	Acc. to EN 61347-2-3/Acc. to EN 60929/Acc. to EN 55015:2006 + A1:2007/Acc. to EN 61000-3-2/Acc. to EN 61547
EEL – Energimerke	A1 BAT
Beskyttelsesklasse	I
Beskyttelses type	IP20

Logistiske data





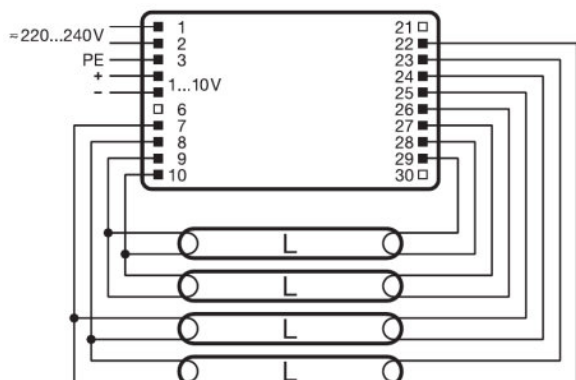





Commodity code	850410809000
----------------	--------------

Koblingsskjema













Wiring diagram

Last ned data

Fil	
	Addon Technical Information 502689_Frequent switching Quicktronic
	Addon Technical Information 502785_ECG lifetime - QUICKTRONIC (DALI) DIM
	Product Datasheet 321505_ATI QT <i>i</i> 4x1424220-240 DIM (G+GB)
	Brochures 335514_Applications and luminaire solutions
	Certificates 334953_EMC-Marks approval
	Certificates 335097_INOTEC
	Certificates 335125_ENECVDE-Marks approval
	Certificates 335135_Manufacturer's declaration – Burning-in of fluorescent lamps
	Certificates 335153_Manufacturer's declaration – Low stand-by
	Certificates 335154_Manufacturer's declaration – EN 55015:2006+A1:2007 (300 MHz)

Produkt datablad

	Certificates 335169_Manufacturer's declaration – LampECG combinations: Frequent switching
	Certificates 592319_EAC certificate for Quicktronics QT
	Certificates 504208_VDE-EMC-CERTIFICATE QTi DALI DIM
	Declarations of conformity 334771_Declaration of conformity
	Installation/Operation notice 334142_Technical guide - ECGs for T5-lamps
	Installation/Operation notice 493509_Technical application guide QUICKTRONIC Intelligent DALI DIM (GB)
	Operating instructions 592412_EAC QTi T5 DIM
	CAD data 3-dim 321639_QTi 4x1424220-240 DIM
	CAD data 3-dim 321640_QTi 4x1424220-240 DIM
	CAD data 3-dim 321641_QTi 4x1424220-240 DIM
	CAD data PDF 321637_QTi 4x1424220-240 DIM

Logistikk data

Product kode	Produkt beskrivelse	Forpakkings enhet (stk/enhet)	Dimensjoner (lengde x bredde x høyde)	Volum	Brutto vekt
4008321069993	QTi 4X14/24 DIM	NO: VS 20	384 mm x 90 mm x 210 mm	7.26 dm ³	8472.00 g

The mentioned product code describes the smallest quantity unit which can be ordered. One shipping unit can contain one or more single products. When placing an order, for the quantity please enter single or multiples of a shipping unit.

Ansvarsfraskrivelse

Endres uten varsel. Sørg alltid for å bruke den nyeste versjonen.

QTi 4X14/24 DIM

QUICKTRONIC INTELLIGENT DIM T5 | ECG dimbar 1...10 V for FL 16 mm

Produktnavn	Lampeggruppe	Nominal wattage + Power loss	Nominell strøm	Lysstrøm ved 35 ° C	Antall belsnings utganger
QTi 4X14/24 DIM	DULUX F 24 W	97.60 W	0.43 A	1800 lm	4
	DULUX L 24 W	98.00 W	0.43 A	1800 lm	4
	FC 22 W	98.00 W	0.43 A	1750 lm	4
	HE 14 W	60.40 W	0.27 A	1200 lm	4
	HO 24 W	98.00 W	0.43 A	1750 lm	4