

## QT-FIT8 3X18,4X18

QUICKTRONIC FIT 8 | ECG til FL 26 mm



### Bruksområder

- Åpne kontorlandskap, korridorer og lagerrom
- Offentlige bygninger
- Lysstriper
- Passer for nødbelysning (likestrømsdrift)
- Egnet for armaturer med beskyttelsesklasse I

### Produktfordeler

- Lang lampelevetid
- Ingen negativ effekt av hyppige tenninger
- Automatisk omstart etter lampebytte
- Perfekt lampestart for bruk med bevegelsessensorer
- VDE/VDE EMC-sertifiseringssystem
- Veldig høy virkningsgrad som følge av utkoblingsteknologi

### Produktegenskaper

- Matespenning: 220...240 V
- Nettspenning: 198...264 V
- Nettfrekvens: 50 Hz | 60 Hz
- lampestart med optimal forvarming av filament
- Energieffektivitetsindeks EEI: A2
- Automatisk utkobling av defekte lamper og ved levetidsslutt (EoL T.2)
- Lampedrift: til EN 60929
- Sikkerhet: to EN 61347-2-3

## Teknisk data

### Elektriske data

Inngangsspenning	198...264 V
Nominell spenning	220...240 V
Nettfrekvensen	50...60 Hz
Likespenning	185...264 V <sup>1)</sup>
Driftfrekvens	40...50 kHz
Maksimalt antall ECG på sikring 10 A	8 <sup>2)</sup>
Maksimalt antall ECG på sikring 16 A	13 <sup>2)</sup>
Startstrøm	15 A

<sup>1)</sup> Minimumsspenning for lampetenning: 198 V, 185 ... 198 V i maksimalt 1 time

<sup>2)</sup> Type B

### Lystekniske data

Starttid	2,0 s
----------	-------

### Mål og vekt

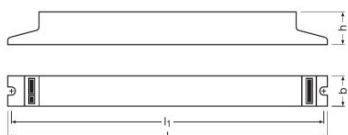

Lengde	280,0 mm
Bredde	40,0 mm
Høyde	28,0 mm
Avstand monteringshull, lengderetning	270,0 mm
Produktvekt	219,00 g
Kabeltverrsnitt, sekundærsiden	0,5...1,5 mm <sup>2</sup> <sup>1)</sup>
Kabeltverrsnitt, primærside	0,5...1,5 mm <sup>2</sup> <sup>1)</sup>

<sup>1)</sup> Massiv leder

### Temperatures & operating conditions

Omgivelsestemperatur-område	-15...+50 °C
-----------------------------	--------------

## Produkt datablad

<b>Relativ fuktighet</b>	5...85 % <sup>1)</sup>
--------------------------	------------------------

<sup>1)</sup> Maksimalt 56 dager/år ved 85 %

### Levetid

<b>ECG levetid</b>	50000 h <sup>1)</sup>
--------------------	-----------------------

<sup>1)</sup> Ved maksimal  $T_c$  / 10% utfallsprosent

### Forventet levetid

Produktnavn	Lampeggruppe				
QT-FIT8 3X18,4X18	L 18 W	ECG omgivelsestemperatur [ta]	40	50	60
		temperatur på tc-punkt [° C]	50	60	65
		levetid [t]	100000	100000	60000
	L 18 W	ECG omgivelsestemperatur [ta]	40	50	60
		temperatur på tc-punkt [° C]	55	60	70
		levetid [t]	100000	90000	50000

### Ytterligere produktdata

<b>Suitable for lamp power (3 lamps)</b>	18 W
<b>Suitable for lamp power (4 lamps)</b>	18 W

### Egenskaper

<b>Egnet for armaturer med beskyttelsesklas</b>	I
<b>Sikker driftsstopp ved endt levetid</b>	EOL T.2
<b>Maksimum ledningslengde, ECG/lampe</b>	1.0 m / 1.5 m
<b>Dimbar</b>	No

### Sertifikater og standarder

<b>Godkjenningsmerke - godkjenning</b>	VDE / VDE-EMC / ENEC 10 / CE
<b>EEI – Energimerke</b>	A2
<b>Standarder</b>	Acc. to EN 61347-2-3/Acc. to EN 60929/Acc. to EN 55015:2006 + A1:2007/Acc. to EN 61000-3-2/Acc. to EN 61547
<b>Beskyttelsesklasse</b>	I
<b>Beskyttelses type</b>	IP20

### Logistiske data

<b>Commodity code</b>	850410809000
-----------------------	--------------

Koblingsskjema

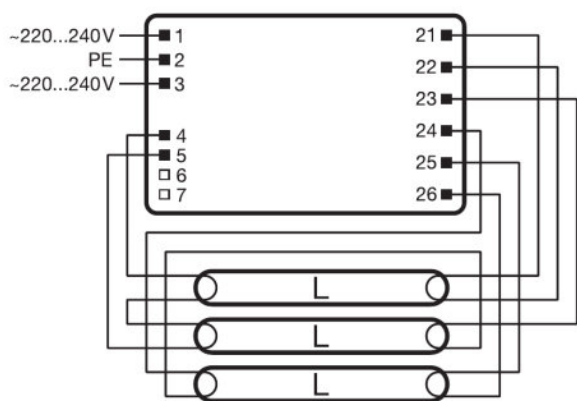

Wiring diagram

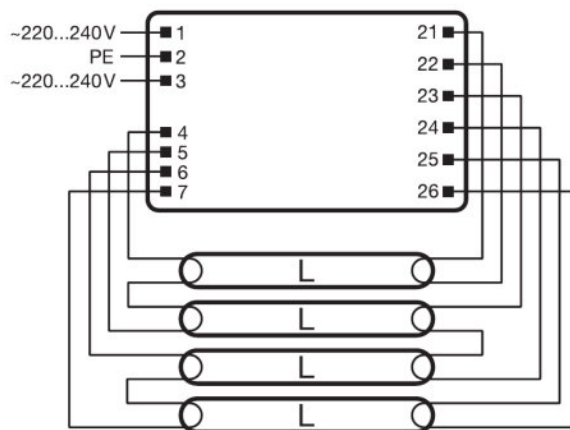



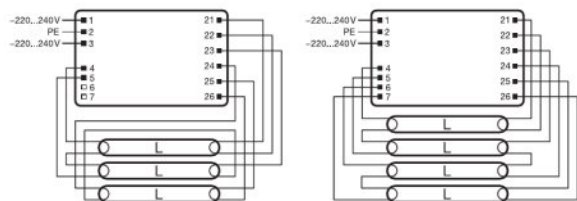













Wiring diagram



Wiring diagram

Last ned data

## Produkt datablad

Fil	
	Product Datasheet 321441_ATI QT-FIT8 3x4x18 (G+GB)
	Product Datasheet 335766_Technical datasheet DEDRA PLUS T8
	Product Family Datasheet 336477_Family data sheet QT-FIT8
	Brochures 333871_LUMILUX ES and OSRAM DULUX D ES &#150; Take a good look at
	Certificates 334974_ENEC-Marks approval
	Certificates 335097_INOTEC
	Certificates 335150_CEAG
	Certificates 335169_Manufacturer's declaration &#150; LampECG combinations: Frequent switching
	Certificates 592319_EAC certificate for Quicktronics QT
	Certificates 504209_VDE-EMC-Certificate QT-Fit8
	Declarations of conformity 334775_Declaration of conformity
	Operating instructions 590720_EAC QT-FIT8
	CAD data 3-dim 316108_QUICKTRONIC QT-FIT8 360x30x28 9900051
	CAD data 3-dim 316109_QUICKTRONIC QT-FIT8 360x30x28 9900051
	CAD data 3-dim 316110_QUICKTRONIC QT-FIT8 360x30x28 9900051
	CAD data PDF 316101_QUICKTRONIC QT-FIT8 360x30x28 9900051

### Logistikk data

Product kode	Produkt beskrivelse	Forpakkings enhet (stk/enhet)	Dimensjoner (lengde x bredde x høyde)	Volum	Brutto vekt
4008321294302	QT-FIT8 3X18,4X18	NO: VS 20	311 mm x 131 mm x 212 mm	8.64 dm <sup>3</sup>	5210.00 g

The mentioned product code describes the smallest quantity unit which can be ordered. One shipping unit can contain one or more single products. When placing an order, for the quantity please enter single or multiples of a shipping unit.

## Produkt datablad

---

### Ansvarsfraskrivelse

Endres uten varsel. Sørg alltid for å bruke den nyeste versjonen.

## QT-FIT8 3X18,4X18

QUICKTRONIC FIT 8 | ECG til FL 26 mm

Produktnavn	Lampeggruppe	Nominal wattage + Power loss	Nominell strøm	Lysstrøm ved 35 ° C	Antall belsynings utganger
QT-FIT8 3X18,4X18	L 18 W	54.00 W	0.25 A	1350 lm	3
	L 18 W	74.00 W	0.33 A	1350 lm	4
	L 18 W XT	54.00 W	0.25 A	1350 lm	3
	L 18 W XT	74.00 W	0.33 A	1350 lm	4
	L 18 W XXT	54.00 W	0.25 A	1350 lm	3
	L 18 W XXT	74.00 W	0.33 A	1350 lm	4